

DataVS2-xx-RE-ID Vision Sensor

QUICK REFERENCE GUIDE

MINIMUM SYSTEM REQUIREMENTS

Check that your Personal Computer meets the following minimum requirements for system interfacing:

- Pentium 1,7 GHz processor
- 1 GB of RAM
- Monitor SVGA (1024x768 pixel)
- Network Connection board 10/100 Mbps
- 50 MB Hard Disk drive free space
- DVD-ROM drive

For best performances the following requirements are recommended:

- Pentium 2 GHz processor
- 2 GB of RAM
- Monitor resolution 1280x768 at least
- Network Connection board 100 Mbps
- 60 MB Hard Disk drive free space
- DVD-ROM drive

DESCRIPTION

The DataVS2 series of vision sensors offers the easiest way to solve the most common machine vision applications.



- Compact IP50 housing
- Red light LED illuminator
- Selectable lens
- Focus ring
- Standard M12 connectors
- Teach button
- Image sensor 640x480 pixel

ELECTRIC CONNECTIONS

<p>M12 4 poles Ethernet: (connectivity)</p> <p>pin 1: White/Orange: Rx+</p> <p>pin 2: White/Green: Tx+</p> <p>pin 3: Orange: Rx-</p> <p>pin 4: Green: Tx-</p>	
<p>M12 8 poles: (power and I/O)</p> <p>pin 1: white : RS-232 Rx</p> <p>pin 2: brown : 24 VDC</p> <p>pin 3: green : Output 4 / Ext. Illuminator Strobe</p> <p>pin 4: yellow : Output 1</p> <p>pin 5: grey : Output 2</p> <p>pin 6: pink : RS-232 Tx</p> <p>pin 7: blue : Ground</p> <p>pin 8: red : External Trigger</p>	

INDICATORS

1. Power, green;
2. Output 1, orange;
3. Output 2, orange;
4. Network connection, green.



CONFIGURATION

Easy Graphic User Interface – Starting Configuration

DataVS2 sensor requires a preliminary setting: this is made in 3 steps by using the Easy GUI interface.

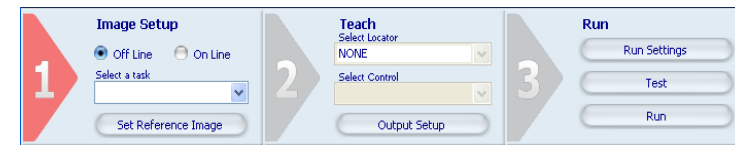

After the start-up of the program, the user is asked to establish a connection to the sensor:

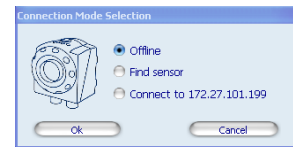

Find sensor: research of the sensors connected to the network
Connect to: connection to the last sensor you have worked with
Offline: open a working session without sensor

If the sensor found is displayed in red, select Configure and follow the instructions

Step 1: Image Setup

The first step allows to handle the connection to the sensor and set the parameters related to the image quality. Once achieved the desired result, the image can be saved and set as reference for the sensor operations

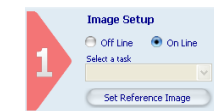

- **Online/Offline** selection
- **Select a Task:** create a new inspection or open an existing inspection from the PC or from the sensor
- **Set Reference Image:** save the image as reference for the following steps

Step 2: Teach

In this step you may configure the desired control.

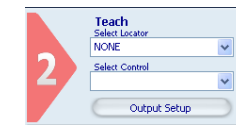

- **Select Locator:** a locator is a special Tool allowing the sensor to find the object inside the image. Once the control is chosen it is added to current inspection. It is possible to add at most one locator to current inspection
- **Select Control:** It allows selecting the controls that will be added to the inspection process. Once the control is chosen it is added to current inspection. It is possible to add more than one control to current inspection.
- **Output Setup :** configuration of the 3 digital outputs.

After selecting the control, it's necessary to position it on the reference image, by clicking in the working area and by moving and resizing the ROI.

The Control Panel displays the control's parameters, initialized to standard values: it is possible to modify them by using the sliders or by directly writing new numeric values.

The STATUS indicator, as well as the ROI contour reveals the result of control application by assuming red (bad result) or green (good result) colouring.

Step 3: Run

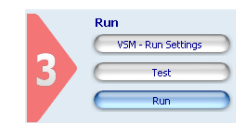

- **VSM \ Run Settings:** configure VSM options and running options for the current inspection.
- **Test:** verification on the PC (Online o Offline) of the selected controls.
- **Run :** store and launch the inspection on the sensor.

CONTROL PANEL

Control	Functioning	Applications
Pattern Match	Searches for a pattern inside the target area	Verifies logo on food packages
Position	Identifies the object position edge (edge detection)	Controls the level of liquids in bottles
OCV	Checks presence of characters on parts	Verifies overprint of labels
Barcode	Searches and decodes the contents of one or more Barcode symbols	Identification
Datamatrix	Searches and decodes the contents of one or more Datamatrix symbols	Identification

COMMUNICATIONS

Communication with the sensor occurs via the Ethernet network.

Direct connection: personal computer is connected directly to device using a "cross cable".



Warning: in case of direct connection the PC requires a fixed IP address

Through LAN: use common network (non-cross) cables normally used to connect devices to routing hubs.

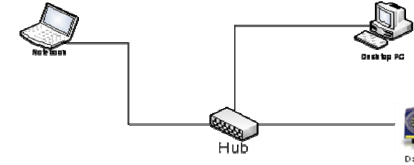

The sensor has the following default IP address:
IP Address: 172.27.101.208
Subnet mask: 255.255.0.0

HARDWARE CONNECTIONS

M12 8 Poles (Power and I/O)

Note: It is not permitted to disconnect the cable at the connector Power and I/O while it is under power.

Power:
Voltage: 24 VDC ± 10%
Current: 200 mA max

Input:
Input ON: > 20 VDC
Input OFF: < 2 VDC

Outputs:
 3 x PNP transistors with short circuit protection
Output Current: 100 mA max
Output Saturation Voltage: < 2 V

NOTE:
 Output 4 is configurable as External Illuminator Strobe.



OPERATING DISTANCE

Operating distance(mm)	DataVS2-16-RE-ID	DataVS2-12-RE-ID	DataVS2-08-RE-ID	DataVS2-06-RE-ID
50	-	16 x 12	24 x 18	34 x 25
80	-	26 x 19	38 x 29	54 x 41
110	-	35 x 26	53 x 40	73 x 55
140	-	45 x 34	67 x 50	95 x 71
170	-	54 x 41	82 x 61	115 x 86
200	48 x 36	64 x 48	196 x 72	136 x 102
300	72 x 54	96 x 72	144 x 108	200 x 150
400	96 x 72	128 x 96	192 x 144	270 x 203
500	120 x 90	160 x 120	240 x 180	338 x 253
600	144 x 108	192 x 144	288 x 216	405 x 304

TECHNICAL DATA

Supply voltage (Vs):	24 Vdc ± 10%
Ripple voltage:	1 Vpp max with illuminator 2 Vpp max without illuminator
Current draw: (excluding output current and illuminator)	100 mA at 24 VDC
Current draw with illuminator: (depends on how long illuminator stays on)	max 200 mA at 24 VDC
Outputs:	3 PNP outputs (short circuit protection) (Output 4 is configurable as External Illuminator Strobe)
Output current:	100 mA max
Output saturation voltage:	< 2 V
Network interface:	M12 4 poles – 10/100 Mbps ethernet
Optics:	Integrated
Resolution:	640 × 480 (VGA)
Dimensions:	69.8 × 51.5 × 40 mm
Indicators:	4 LED
Setup:	1 Teach-In button
Data retention:	Non-volatile FLASH memory
Operating temperature:	-10 °C ... +55 °C
Storage temperature:	-25 °C ... +75 °C
Vibrations: (EN60068-2-6)	14 mm @ 2 to 10 Hz; 1.5 mm @ 13 to 55 Hz;
2 hours on each axis	2 g @ 70 to 200 Hz
Shock resistance: (EN60068-2-27)	11 ms (30 G) 6 shock for every axis
Housing material:	Aluminium alloy / ABS
Mechanical protection:	IP50
Connections:	M12 8 pole A-code, M12 4 pole D-code
Weight:	125 g

MECHANICAL DIMENSIONS

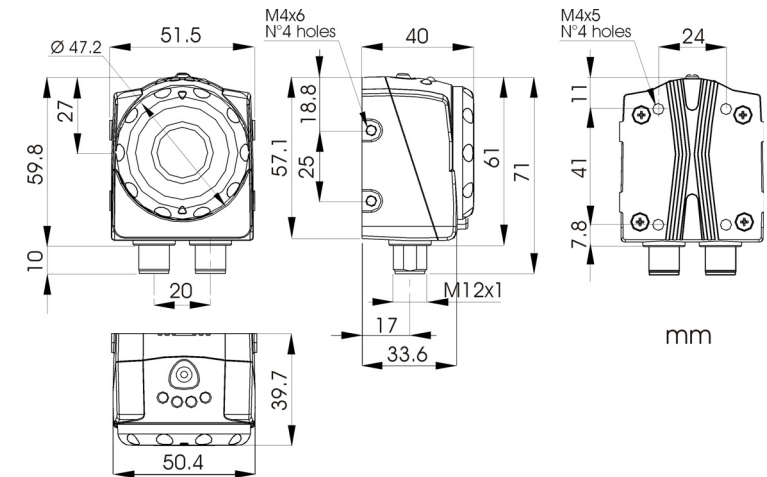

COMPLIANCE

Only connect Ethernet and dataport connections to a network which has routing only within the plant or building and no routing outside the plant or building.

CE COMPLIANCE

Warning: This is a Class A product. In a domestic environment this product may cause radio interference in which case the user may be required to take adequate measures.

FCC COMPLIANCE

Modifications or changes to this equipment without the expressed written approval of Datalogic could void the authority to use the equipment.

This device complies with PART 15 of the FCC Rules. Operation is subject to the following two conditions: (1) This device may not cause harmful interference, and (2) this device must accept any interference received, including interference which may cause undesired operation.

This equipment has been tested and found to comply with the limits for a Class A digital device, pursuant to part 15 of the FCC Rules. These limits are designed to provide reasonable protection against harmful interference when the equipment is operated in a commercial environment. This equipment generates, uses, and can radiate radio frequency energy and, if not installed and used in accordance with the instruction manual, may cause harmful interference to radio communications. Operation of this equipment in a residential area is likely to cause harmful interference in which case the user will be required to correct the interference at his own expense.

DECLARATION OF CONFORMITY

We DATALOGIC AUTOMATION declare under our sole responsibility that these products are conform to the 2004/108/CE and successive amendments.

WARRANTY

DATALOGIC AUTOMATION warrants its products to be free from defects. DATALOGIC AUTOMATION will repair or replace, free of charge, any product found to be defective during the warranty period of 24 months from the manufacturing date. This warranty does not cover damage or liability deriving from the improper application of DATALOGIC AUTOMATION products.

DATALOGIC AUTOMATION

Via Lavino 265 - 40050 Monte S. Pietro - Bologna - Italy
 Tel: +39 051 6765611 - Fax: +39 051 6759324
 www.datalogic.com e-mail: info.automation.it@datalogic.com



DATALOGIC AUTOMATION cares for the environment: 100% recycled paper. DATALOGIC AUTOMATION reserves the right to make modifications and improvements without prior notification.

Datalogic and the Datalogic logo are registered trademarks of Datalogic S.p.A. in many countries, including the U.S.A. and the E.U.